

Preparation

**Part Number: PT912-35070**

**NOTE:** Part number of this accessory may not be the same as the part number shown.

**Kit Contents**

Item #	Quantity Reqd.	Description
1	1	Bezel Assembly
2	1	Paper Template
3	1	Hardware Bag

**Hardware Bag Contents**

Item #	Quantity Reqd.	Description
1	9	Push Pin Fasteners

**Additional Items Required For Installation**

Item #	Quantity Reqd.	Description
1		Masking Tape

**Conflicts**

--

**Recommended Tools**

<b>Personal &amp; Vehicle Protection</b>	<b>Notes</b>
Eye Protection	Safety Glasses
<b>Special Tools</b>	<b>Notes</b>
None	
<b>Installation Tools</b>	<b>Notes</b>
Drill	
Drill Bit w/Drill Stop	3mm (1/8")
Drill Bit w/Drill Stop	6.5mm (1/4")
Center Punch	
<b>Special Chemicals</b>	<b>Notes</b>
None	

**General Applicability**

--

**Recommended Sequence of Application**





Item #	Accessory
1	
2	
3	

\*Mandatory

**Vehicle Service Parts** (may be required for reassembly)

Item #	Quantity Reqd.	Description
1		
2		
3		

**Legend**

	<b>STOP:</b> Damage to the vehicle may occur. Do not proceed until process has been complied with.
	<b>OPERATOR SAFETY:</b> Use caution to avoid risk of injury.
	<b>CAUTION:</b> A process that must be carefully observed in order to reduce the risk of damage to the accessory/vehicle and to ensure a quality installation.
	<b>TOOLS &amp; EQUIPMENT:</b> Used in Figures calls out the specific tools and equipment recommended for this process.

Care must be taken when installing this accessory to ensure damage does not occur to the vehicle. The installation of this accessory should follow approved guidelines to ensure a quality installation.

These guidelines can be found in the "Accessory Installation Practices" document.

This document covers such items as:-

- Vehicle Protection (use of covers and blankets, cleaning chemicals, etc.).
- Safety (eye protection, rechecking torque procedure, etc.).
- Vehicle Disassembly/Reassembly (panel removal, part storage, etc.).
- Electrical Component Disassembly/Reassembly (battery disconnection, connector removal, etc.).

Please see your Toyota dealer for a copy of this document.

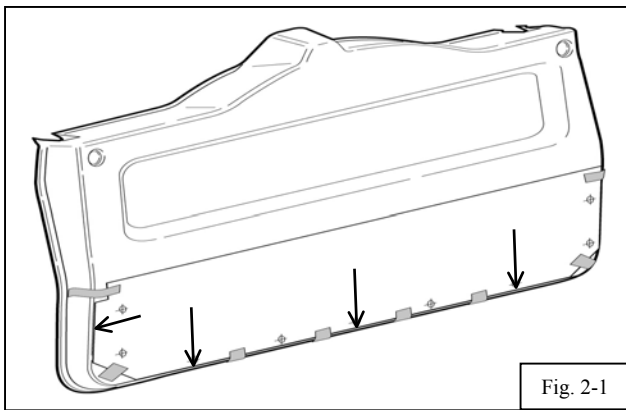

Fig. 2-1

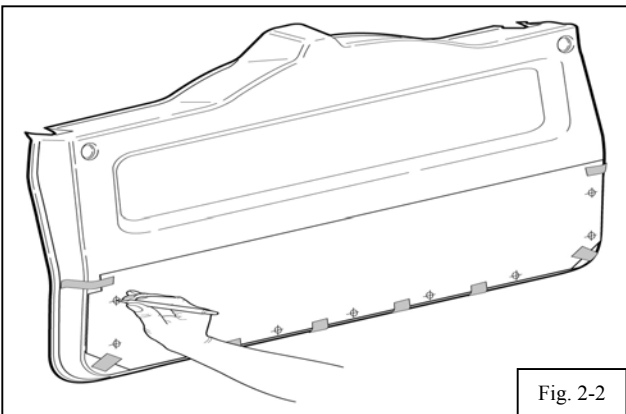

Fig. 2-2

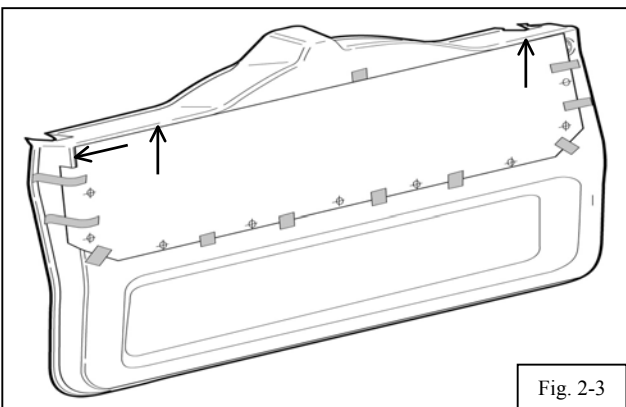





Fig. 2-3

**1. Preparation.**



- (a) Open carton and check for damage and content.
-  (b) Read instructions thoroughly before beginning installation.
- (c) Cut out paper template.
- (d) Open rear door.

**2. Affix Template and Mark Holes.**

**For Lower Location Installation**

-  (a) Align lower edge of paper marking template to lower edge of back door panel. (Fig. 2-1)
-  (b) Align left edge of paper drill template to left edge of rear door panel. (Fig. 2-1)
- (c) Use tape at locations indicated on the template to hold the template in place. (Fig. 2-2)
- (d) Use center punch to mark the centers of the (9) holes. (Fig. 2-2)
- (e) Remove the paper template.

**For Upper Location Installation**

-  (a) Align upper edge of paper marking template to upper edge of back door panel. (Fig. 2-3)
-  (b) Align cutout on upper left corner of paper drill template to upper left corner of back door panel. (Fig. 2-3)

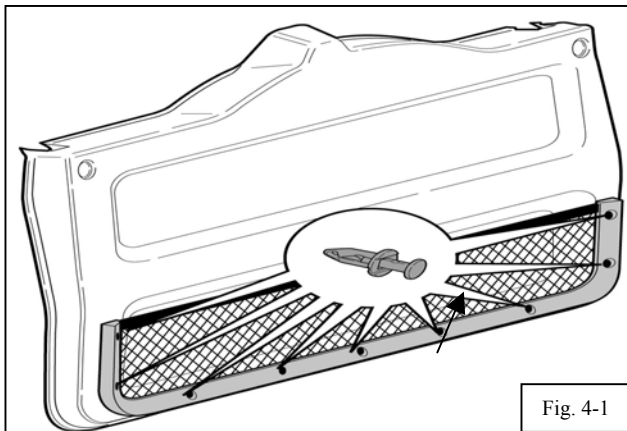
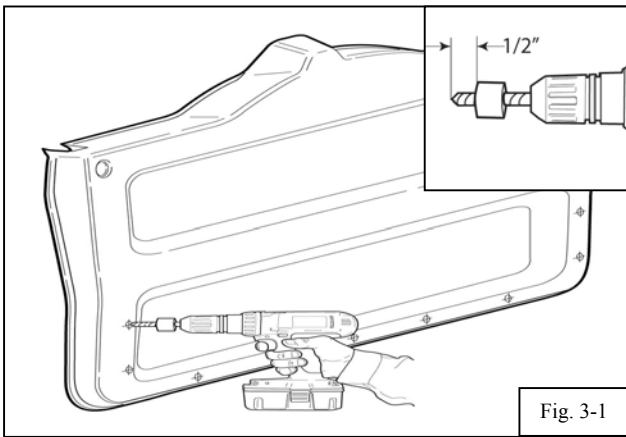
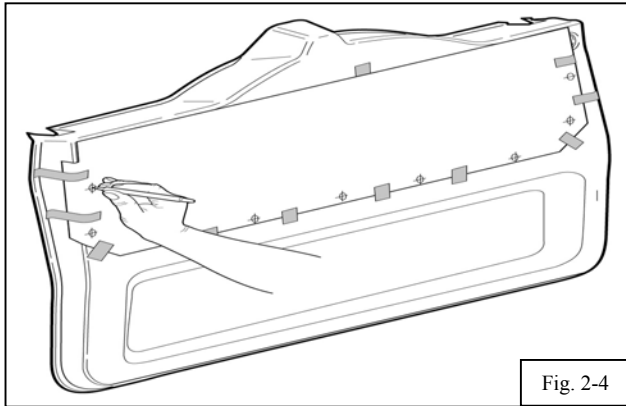

- (c) Use tape at locations indicated on the template to hold the template in place. (Fig. 2-3)
- (d) Use center punch to mark the center of the (9) holes. (Fig. 2-4)
- (e) Remove the paper template.

**3. Drill the Back Door Panel (lower location shown).**

- (a) Using the 1/8" drill bit, pilot drill the (9) center punched hole locations. (Fig 3-1)



(1) Drill stop must be set at a maximum depth of 1/2".

- (b) Using the 1/4" drill bit, enlarge the previously drilled pilot drilled holes. (Fig 3-1)



(1) Drill stop must be set at a maximum depth of 1/2".

**4. Install the Bezel/Net Assembly (lower location shown).**

- (a) Place the bezel assembly onto the back door panel and align with the drilled holes.
- (b) Insert one of the nine fasteners in each hole and push to engage. (Fig. 4-1)



(1) Start with the center hole and work outward.

Because of the tension of the net, the bezel will have to be "stretched" to align with the side holes.



Make sure bezel is flush to back door panel when engaging push fasteners.



(2) Push firmly to make sure the fastener heads are fully seated.

**TOYOTA FJ CRUISER 2007 - REAR DOOR STORAGE**  
Checklist - these points **MUST** be checked to ensure a quality installation.

Check:

Look For:

Accessory Function Checks

- Perform visual check of Rear Door Storage Net

No gaps of over 1mm between Bezel and back door panel.

No loose push fasteners.

Push fastener heads fully seated.

Vehicle Function Checks

Clearance between Rear Door Storage Net and vehicle components.

Rear Door Storage Net should not contact interior side panels.

Rear Door Storage Net should not contact threshold panel.